

Panel options for _A2 series / _K2 serial series HMIs _A2系列 / _K2序列型人機介面 前置選購機種 _A2系列 / _K2串口型人機介面 前置選購機種

Outlet dimension / 外觀尺寸 / 外觀尺寸

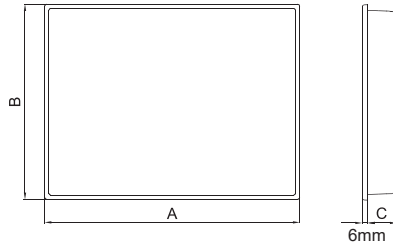

Cut out dimension / 開孔尺寸 / 開孔尺寸

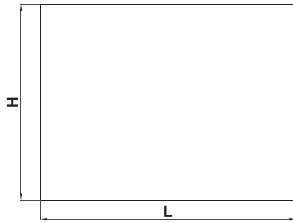

Model	A	B	C*	L	H
_A2070 & _K2070	203.5mm/8.01"	148.5mm/5.85"	31.5mm/1.24"	191.5mm/7.54"	138mm/5.43"
_A2100 & _K2100	270.8mm/10.66"	212.8mm/8.38"	37mm/1.46"	259mm/10.20"	201mm/7.91"

* _A2070&_K2070&_A2100&_K2100:
Including power connector height / 包含電源端子高度 / 包含電源端子高度

1

Function view / 功能配置圖 / 功能配置圖

_A2100- _OUT & _K2100- _OU _

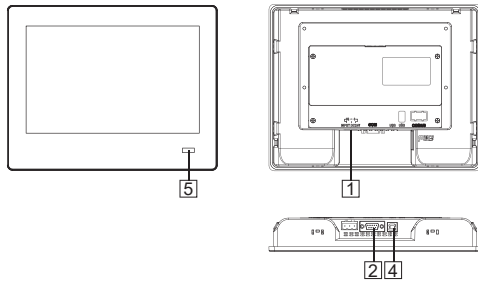

_A2100- _OFT & _K2100- _OF _

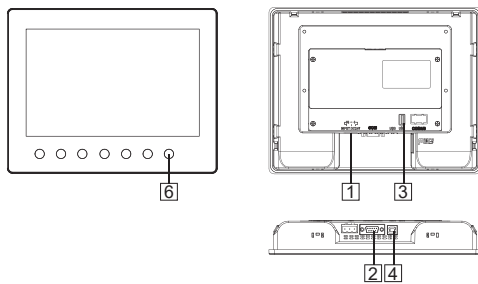

_A2100- _OKT & _K2100- _OK _

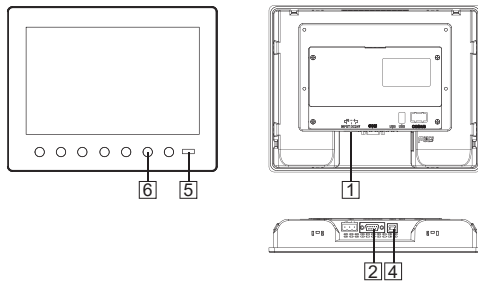

3

Installation drawing for locks / 固定件安裝示意圖 / 鎖具安裝示意圖

Plastic locks / 塑膠安裝固定件 / 塑料安裝鎖具

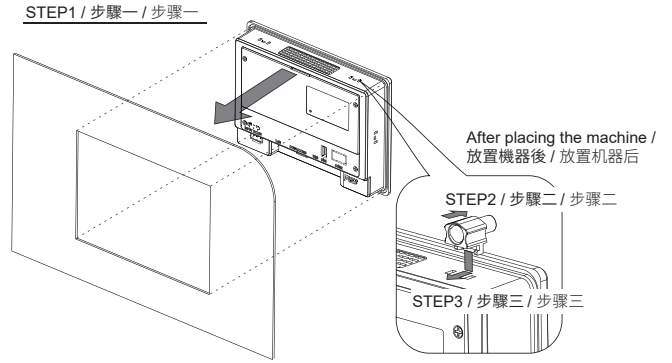

Metal locks / 金屬安裝固定件 / 金屬安裝鎖具

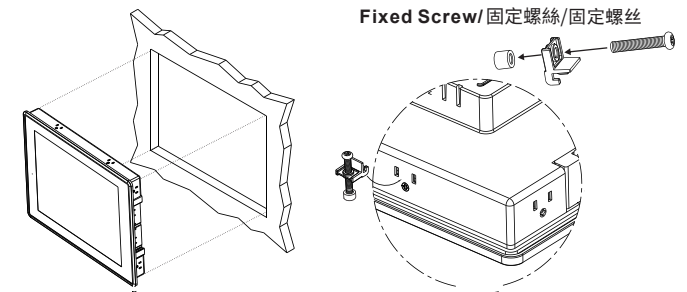

Tighten each fixing screw until the bezel corner gets in contact with the panel.
使用固定螺絲固定時請注意不要鎖太緊，以避免壓迫造成其他問題 /
使用固定螺絲固定時請注意不要鎖太緊，以避免壓迫造成其他問題
Suggested torque for fixing screws: 0.25~0.34Nm /
固定螺絲扭力建議值:0.25~0.34Nm / 固定螺絲扭力建議值:0.25~0.34Nm

2

_A2070- _OUT & _K2070- _OU _

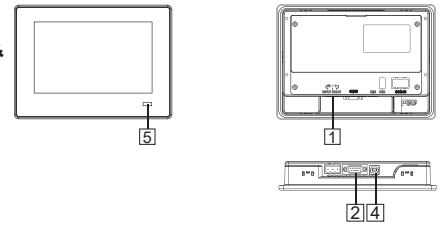

_A2070- _OFT & _K2070- _OF _

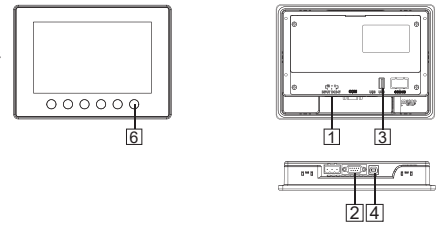

_A2070- _OKT & _K2070- _OK _

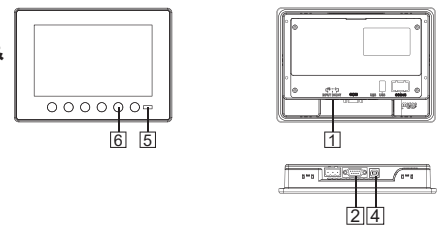

- 1 Power connector / 電源端子 / 電源端子
- 2 D-Sub 9Pin female / D-Sub 9Pin 母座 / D-Sub 9Pin 母座
- 3 USB host / USB 主接口 / USB 主接口
(Only OFT / OF_ type support / 僅 OFT / OF_ 機種支援 / 仅 OFT / OF_ 機種支持)
- 4 USB client / USB 從接口 / USB 從接口
- 5 Front USB host / 前置 USB 主接口 / 前置 USB 主接口
- 6 Front function keys / 前置功能鍵 / 前置功能鍵

You can use the USB host positioning at either the front or the rear of the HMI case only.
前置與後方USB接口只能擇一，無法同時使用。
前置与后方USB接口只能择一，无法同时使用。

4

Power supply / 電源供應 / 电源供应



Powered by low voltage / Limited energy power source.
以低電壓提供電力/限制能源電源 / 以低电压提供电力/限制能源电源

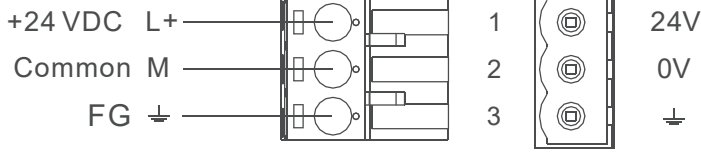

Do not open the rear cover of the panel when power is applied.
電源送電時請勿開啟後殼 / 电源送电时请勿开启后壳



Be sure that the power supply has enough power capacity for the operation of the equipment.
送電時請確定電源設備的電源能力符合產品硬體規範。
送电时请确定电源设备的电源能力符合产品硬体规范。

· _A2070 & _A2100 & _K2070 & _K2100 : 24VDC±10% / 0.8A

Dispose of batteries / 電池處置 / 电池处置



CR 2450H

Panasonic 3V 600mAh
Lithium coin unchargeable
battery type
一次性電池 / 一次性电池



Dispose of batteries according to local regulations.
廢棄電池的處置請依據使用者所在地區之規範辦理廢棄電池處置方式。 /
废弃电池的处置请依据使用者所在地对废弃电池处置方式办理。

5

Pin Diagram / 腳位圖 / 脚位图

		COM1 & COM2 DB-9-female / DB-9 母座 / DB-9 母座	Pin	Description
			_A2070 & _A2100	20UT & 20KT & 20FT (選購/選購/ Optional)
2	RS232 RXD (COM1)			
3	RS232 TXD (COM1)			
4	RS422 RXD+ (COM2)			
5	SG			
6	RS422 TXD- / RS485 - (COM2)			
7	N/A			
8	N/A			
9	RS422 RXD- (COM2)			
	30UT & 30KT & 30FT	COM1 & COM2 & COM3 DB-9-female / DB-9 母座 / DB-9 母座	Pin	Description
			1	RS422 TXD+ / RS485 + (COM2)
			2	RS232 RXD (COM1)
			3	RS232 TXD (COM1)
			4	RS422 RXD+ (COM2)
			5	SG
			6	RS422 TXD- / RS485 - (COM2)
			7	RS485 - (COM3)
			8	RS485 + (COM3)
9	RS422 RXD- (COM2)			
	40UT & 40KT & 40FT (選購/選購/ Optional)	COM1 & COM2 & COM3 & COM4 DB-9-female / DB-9 母座 / DB-9 母座	Pin	Description
			1	RS485 + (COM2)
			2	RS232 RXD (COM1)
			3	RS232 TXD (COM1)
			4	RS485 + (COM4)
			5	SG
			6	RS485 - (COM2)
			7	RS485 - (COM3)
			8	RS485 + (COM3)
9	RS485 - (COM4)			

(page 7 for PK2 serial series / 更多腳位請看第七頁 / 更多脚位请看第七頁)

6

		COM1 & COM2 DB-9-female / DB-9 母座 / DB-9 母座	Pin	Description
			_K2070 & _K2100	20U_ & 20K_ & 20F_ (選購/選購/ Optional)
2	RS232 RXD (COM1)			
3	RS232 TXD (COM1)			
4	RS422 RXD+ (COM2)			
5	SG			
6	RS422 TXD- / RS485 - (COM2)			
7	N/A			
8	N/A			
9	RS422 RXD- (COM2)			
	30U_ & 30K_ & 30F_	COM1 & COM2 & COM3 DB-9-female / DB-9 母座 / DB-9 母座	Pin	Description
			1	RS422 TXD+ / RS485 + (COM2)
			2	RS232 RXD (COM1)
			3	RS232 TXD (COM1)
			4	RS422 RXD+ (COM2)
			5	SG
			6	RS422 TXD- / RS485 - (COM2)
			7	RS485 - (COM3)
			8	RS485 + (COM3)
9	RS422 RXD- (COM2)			
	40U_ & 40K_ & 40F_ (選購/選購/ Optional)	COM1 & COM2 & COM3 & COM4 DB-9-female / DB-9 母座 / DB-9 母座	Pin	Description
			1	RS485 + (COM2)
			2	RS232 RXD (COM1)
			3	RS232 TXD (COM1)
			4	RS485 + (COM4)
			5	SG
			6	RS485 - (COM2)
			7	RS485 - (COM3)
			8	RS485 + (COM3)
9	RS485 - (COM4)			

The products have been designed for use in an industrial environment in compliance with the 2014/30/EU directive.
本產品適用於工業環境並符合2014/30/EU 標準 / 本产品适用于工业环境并符合2014/30/EU标准

The products have been designed in compliance with:
本產品符合以下標準: / 本产品符合以下标准:

- EN 61000-6-4: 2007 +A1: 2011
- EN 61000-3-2: 2014
- EN 61000-3-3: 2013
- EN 61000-6-2: 2005 / AC: 2005
- IEC 61000-4-2: 2008; IEC 61000-4-3: 2006 + A1: 2007 +A2: 2010;
- IEC 61000-4-4: 2012; IEC 61000-4-5: 2014 + A1: 2017; IEC 61000-4-6: 2013;
- IEC 61000-4-8: 2009; IEC 61000-4-11: 2004 + A1: 2017

The installation of these devices into the residential, commercial and light-industrial environments is allowed only in the case that special measures are taken in order to get the conformity to IEC-61000-6-3
本產品若要安裝於住宅; 商業及輕工業的環境時, 必須加測特殊檢驗以符合 IEC-61000-6-3 /
本产品若要安装于住宅; 商业及轻工业的环境时, 必须加测特殊检验以符合 IEC-61000-6-3

Reproduction of the contents of this copyrighted document, in whole or part without written permission of Cermate Technologies Inc., is prohibited. \

本文件內容版權為Cermate Technologies Inc.所有, 非經本公司同意, 請勿自行重製、拷貝或修正文件內容
本文件內容版權為Cermate Technologies Inc.所有, 非經本公司同意, 請勿自行重製、拷貝或修正文件內容

Battery replacement installation / 替代電池安裝說明 / 替代电池安装说明

Please scan QR Code to download the installation guide. /
請掃描QR Code下載說明文件 / 请扫描QR Code下载说明文件

- * Note: It will affect the product warranty, if open the rear cover and damage the "Void if torn" Warranty label. Please contact us for details. /
- * 注意: 若於產品保固期限內自行開啟產品後殼造成「撕毀保固無效」貼紙損毀將會影響產品保固。相關保固問題請跟本公司聯絡詢問 /
- * 注意: 若于产品保固期限内自行开启产品后壳造成「撕毁保固无效」贴纸损毁将会影响产品保固。相关保固问题请跟本公司联络询问



<https://reurl.cc/o9WZqM>

7

8